



## Index For Synway's SBC Series Session

<b>SMG1000 (FXO/FXS Analog Gateway, 4~32Chs).....</b>	<b>2</b>
<b>SMG2000L (Mini-Sized Digital Gateway, PRI, 1~2 E1/T1) .....</b>	<b>4</b>
<b>SMG2000/3000 (Digital Gateway, PRI/SS7/SIGTRAN, 1~64E1/T1) .....</b>	<b>6</b>
<b>SMG4000 (Wireless Gateway, GSM/WCDMA/VoLTE, 4~32Chs) .....</b>	<b>8</b>
<b>UNIWAY (Hybrid Modular Gateway, Analog/Digital/Wireless) .....</b>	<b>11</b>
<b>SBO (Transcoding Gateway in IP network, 500~2,000Chs).....</b>	<b>13</b>
<b>SIM Bank (Manage the SIM Cards) .....</b>	<b>14</b>
<b>WEB Management Interface (For All Gateways).....</b>	<b>16</b>
<b>DCMS (Cloud-based Management System) .....</b>	<b>17</b>
<b>Typical Applications (For all Gateway Products).....</b>	<b>18</b>

# SMG1000

## FXO/FXS VoIP Gateway

- Support 2~32FXS/FXO Ports, Field Approved Globally
- Superior Voice Quality by Designated DSP Chipsets
- User-Friendliness and Web-based Administration

With a simple and economical way to help legacy telephone, fax machine and PBXs interconnect with IP network. Synway SMG1000 analog gateway enables call center and multi-branch enterprises to possess powerful, versatile and efficient VoIP solutions with unparalleled cost advantages.

SMG1000 Analog Gateway allows for a well-planned, phased migration to an IP network, making the gateways an easy solution for enterprises looking to enhance their legacy PBX equipment with new VoIP access and applications. Connected between a PBX or a LAN, the SMG1000 Gateway converts analog PSTN messages into a format suitable for transmission over standard IP networks.



### Key Features and Benefits

- Fit to Diverse Applications

Used to connect IP telephones to a legacy PBX, integrate network-hosted applications with the PBX, extend the PBX to branch offices, and integrate various voice and call processing capabilities in an enterprise LAN or WAN environment.

- Flexible Call Routing

Route calls from the switched network to a VoIP destination on the IP network or conversely, and support the following call routing options: TDM to IP or IP to TDM, with IP load balancing, IP fault tolerance.

- Controlled Migration to IP

Compatible with general FXO/FXS lines, and a variety of popular PBX manufacturers (Digital PSTN lines compliance would be available), and protects investment in legacy telecommunications equipment.

- User-Friendly Management

Supports configuration via serial, Telnet, and a web browser including context-sensitive help  
Easy to install, configure, debug, and maintain.

- Enhanced Voice/Fax Processing

Supports a variety of compression algorithms, including G.711 A-law and  $\mu$ -law, G.729A/B; Transcode fax from T.30 fax protocol (supporting V.17) to T.38 for transmission over a packet network.

- Web Server Interface & Hot Swap

Each gateway unit is delivered with a web server interface, allowing configuration and software upgrades via a web browser; Allows gateway units to be added or removed without affecting other gateway.

Technical Specification:					
Features	Model	SMG1004	SMG1008	SMG1016	SMG1032
Model		SMG1004-2S20 SMG1004-4S SMG1004-4O	SMG1008-4S4O SMG1008-8S SMG1008-8O	SMG1016-8S8O SMG1016-16S SMG1016-16O	SMG1032-16S16O SMG1032-32S SMG1032-32O
Sessions		4	8	16	32
Telephony ports		4	8	16	32
Interface		RJ11	RJ11	RJ11, RJ21, RJ45	RJ11, RJ21, RJ45
LAN		1*10/100Mbps		2*10/100Mbps	
Console Port		N/A		1	
Signaling		SIP/TDM			
Power Supply		Single			
Power Requirements		12V DC		AC Frequency 47 Hz to 63 Hz	
Codecs		G.711/729/723/722/iLBC/AMR			
DTMF Mode		RFC2833, SIP Info, In-band			
Fax		T.38 and Pass-through			
QoS		DiffServ, ToS, 802.1 P/Q VLAN tagging			
Network		DHCP, PPPoE, Static Route, VLAN			
Network Protocol		TCP/UDP, HTTP, ARP/RARP, DNS, NTP, TFTP, TELNET, STUN			
Management Protocol		TR-069*			
Signaling		FXS Loop Start, FXS Kewl Start			
Caller ID		BELL202, ETSI (V23), NTT (V23-Japan), and DTMF-based CID			
FXO Connectivity		Programmable AC Impedance, Hangup Detection, Answer Detection, Caller ID Detection			
Dimensions H*W*D(mm)		220*148*40		440*267*44	
Routing		Call routing(IP ↔PSTN)			
Mounting		Desktop		Wall-mount	
Compatibility		Interoperable with most IP-PBX and UC Platform, and field-proven by SMB and Carriers Worldwide			
Environment		Operating temperature range :0 to +55 °C, 8-90% relative humidity non-condensing Storage temperature range:-20 to +85 °C, 8-90% relative humidity non-condensing			
Safety		Compliant with most international standards, please ask Synway or its sales representatives worldwide. Synway would comply all new safety standard to for different regions around the world while needed.			
EMC/EMI		Compliant with most international standards. For compliance documents, please contact Synway's sales representatives.			
OAM&P		Network Time Protocol(NTP) Web User interface (WebUI) supports configuration via browser SNMP MIBs			

# SMG2000L

## Mini Size E1/T1 VoIP Gateway

- Support 1/2 E1(T1 Optional) in Mini Size
- Support SIP and SS7/ISDN/R2/CAS and More
- Superior Voice Quality and Reliability in Full Load
- Only 30mm\*190mm \*120mm(High\*Wide\*Deep)

The Synway SMG2030L/2060L, with mini size for better space and shipment efficiency, are new members of Synway's VoIP gateway family that enables service providers and enterprises to maximize value of their networks and services. It converts digital E1/T1 PSTN message into IP formats and secures sessions across IP and mixed network boundaries to support the seamless delivery of services.

SMG2030L/2060L are unparalleledly cost effective and compliant with PRI ISDN, R2 and SS7 packets, and adopt the equivalent hardware architecture like Synway's Telco' grade SMG3000 series, with dedicated DSP chipsets for processing IP/TDM signaling and optimizing voice quality. Compared with rival products, SMG2000L features high reliability and unmatched cost, and delivers a perfect alternative option for enterprises, operators and system integrators.

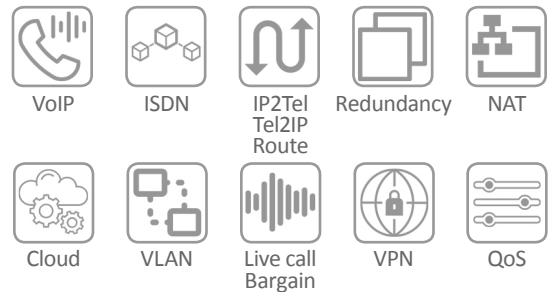

### Key Features and Benefits

- **Flexible Scalability**  
From 30 to 60 simultaneous SIP sessions with multimedia transcoding provides high performance in a small footprint to help lower ownership cost and operational cost; a broad range of gateway toolkits help gateway's maintenance and software upgrading for Web UI, gateway services and firmware.
- **Flexible and efficient Gateway Solution**  
Provide a clear migration path to an all-IP network. It can scale up to 60 simultaneous IP sessions and at the same time provide media transcoding and impressive sessions per second performance; Support SS7 signaling, call routing, call automated failover from IP to TDM for outbound routing.
- **Any-to-Any Signaling and Transcoding**  
Provide any-to-any network connectivity through its ability to interwork multiple protocols to deliver services. It can provide interworking between SS1, R2, ISDN, SS7, SIP formats and any-to-any media transcoding for popular voice codecs, T.38 and G.711 fax interworking, RTP, INBAND and SIPINFO.
- **User-Friendly Management & Toolkits**  
The Web graphical user interface (WebUI) is a real-time web toolkits to configure and monitor and perform real-time monitoring and maintenance. Flexible SIP and Protocols configuration help to configure SIP, SIP trunking, SIP Mediation, PCM, SS7 and ISDN, Routing and more.
- **Combined All Features on A Single Platform**  
Integrated multimedia gateway features facilitate TDM and IP interworking to provide service delivery flexibility and automated failover between domains.
- **Integrated Transcoding for Voice, Tone and Faxing**  
Eliminates the need to add separate hardware to support transcoding requirements helping to reduce CAPEX and number of platforms deployed, and support a range of Codecs, including G.723, G.729, G.711, iLBC, SIPINFO, RFC2833, RF3261, INBOUND and more.

Technical Specification:			
Features	Model	SMG2030L	SMG2060L
Sessions		30	60
Routing Features	Call routing and translation (from PCM to IP or reversely)		
IP Interfaces	Dual redundant 2 *100 Base-T Ethernet for VoIP payload and signaling		
IP protocols	TCP/UDP, HTTP, ARP/RARP, DNS, NTP, TFTP, TELNET, STUN, etc.		
Coder support	G.711A,G.711U, G.729 A/B,G723,G722, GSM, iLBC, RFC 2833,RF 3261,SIPINFO,INBOUND		
Power Supply	Single		
TDM Signaling Protocols	ISDN PRI/MF R2/SS7 ISUP/SS7 MTP1~3/SS7 SIGTRAN/SS7 TCAP		
Power Requirements	12V DC		
Mounting	Desktop		
Compatibility	Interoperable with most IP-PBX and UC Platform, and field-proven by SMB and Carriers Worldwide		
Dimensions H*W*D(mm)	30*190*120		
Environment	Operating temperature range :0 to +55 °C, 8-90% relative humidity non-condensing Storage temperature range:-20 to +85 °C, 8-90% relative humidity non-condensing		
Routing	Call Routing and translation (PCM↔IP)		
Safety	Compliant with most international standards, please ask Synway or its sales representatives worldwide. Synway would comply all new safety standard to for different regions around the world while needed.		
EMC/EMI	Compliant with most international standards. For compliance documents, please contact Synway's sales representatives.		
OAM&P	Network Time Protocol(NTP) Web User interface (WebUI) supports configuration via browser SNMP MIBs		
Dedicated DSP-Empowered Capability	Telecom-style DSP algorithm has been optimized for over decades, assuring seamless compliance with any network environment. Plentiful DSP resources are allocated for signaling, media processing, bandwidth optimization, Telco redundancy		
Highly Adjustable For Diverse SoftSwitch	Homegrown core technologies to assure seamless compliance with diverse softswitch platform Including Mitel, Avaya, Broadsoft, Yate, OpenSIP, Asterisk, VECTRA, VSC, SIPPULSE, Tropic, FreeSwitch and more other softswitch		

# SMG2000/3000

## Hi-Availability E1/T1 PRI/SS7/SIGTRAN VoIP Gateway

- Support 1/2/4/8/16/63 E1(T1 Optional)in 1U Space
- Support SIP and SS7/ISDN/R2 and More
- Telco-grade Redundancy & Dual Power Supply

With a more efficient manner to interconnect and deliver large-scalability services, The Synway SMG2000/3000 enables service providers and carriers to maximize value of their networks and services. The SMG2000/3000 converts digital PSTN message into IP formats and connects and secures sessions across IP and mixed network boundaries to support the seamless delivery of services.

The SMG2000/3000 connects IP and hybrid networks via telephony and E1(T1 or STM-1)/Ethernet links in a compact 1U form factor appliance. It also transforms media and signaling to support efficient and reliable voice, fax and multimedia sessions for mobile, fixed and cloud-based applications. The convergence of IP multimedia and TDM gateway functionality in a single chassis in the SMG offers significant reductions in investment and operational cost when compared to less integrated alternatives.

SMG3000R inbuilt call classification/analytics is vital for hi-density OBD applications, including predictive dialing, dialer, telemarketing and more. It helps minimize dialing cost and maximize value of dialing (human and network) resources. With call classification, OBD applications could improve dialing efficiency by up to 60% and deliver high satisfaction for both agents and subscribers.



VoIP



SS7



IP2Tel  
Tel2IP  
Route



Redundancy



NAT



Cloud



VLAN



Radius



VPN



QoS

### Key Features and Benefits

- Build-in SS7, SIGTRAN, SIP, R2 & More Protocols

Complimentary standardized SS7 Packets(Up to 64 SS7 links, ISUP, MTP1~3, TCAP), SIGTRAN and SIP for any carrier networks worldwide; Field-proven by over 50 largest operators from European, China, USA, India, Brazil, South America.

- Dedicated DSP-Empowered Capability

Telecom-style DSP algorithm has been optimized for over decades, assuring seamless compliance with any network environment. Plentiful DSP resources are allocated for signaling, media processing, bandwidth optimization, Telco redundancy.

- Robust Telco-Grade Architecture

Dual power supply, 1U compact structure, industrial heating sink system, dual 1,000M Ethernet interfaces, and Telco' grade hardware architecture ensures 200,000Hr MTBF and 0-defective rate in long lifecycle.

- Highly Adjustable For Diverse SoftSwitch

Homegrown core technologies to assure seamless compliance with diverse softswitch platform, including Mitel, Avaya, Broadsoft, Yate, OpenSIP, Asterisk, VECTRA, VSC, SIPPULSE, Tropic, FreeSwitch and more other softswitch;

- 99.9999% Availability in Full Load

Support 1~64E1 (30~1,920Chs) per unit, with higher system responsiveness capability in extreme network for better operational results; High performance and stability in cases of unstable (low) bandwidth and high capacity.

- User-friendly WEB Management

With complete understanding about SPs and operator's headaches, SMG2000/3000 adopts the simplest and straight-forward configuration to achieve SPs and Operators' most sophisticated objectives. Over 10000 units of SMG2000/3000 can run together.

## Key Features and Benefits

- Improve Dialing Efficiency

In general database of OBD systems, unused numbers accounts for 10~ 30%, suspended numbers for 5~ 20%, shutdown number for 5~10%. It means around 20~ 60% dialing numbers are invalid. With call classification function, dialing systems (predictive dialer) could filter out all invalid numbers for best dialing results.

- Reduce Operational Expenditure (OPEX) by 20%

Unsuccessful dialing incurs higher operational costs while labor cost for telemarketing is specifically considered. According to analytical statistics from surveys, OPEX could be reduced by 20% or more if successful dialing ratio increases by 60%.

- Hi-Accuracy Call Classification

With call classification functionality, over 99.999 % ( in some scenarios) of called number states could be accurately detected by analyzing telephone alert tones. Only in much noise conditions over the network, call classification may default.

- Minimize Your Hardware Cost

High voice quality and instant call connection, improving system efficiency and profitability; Synway SS7 VoIP Gateway could reduce hardware cost by 70%.

- High Interoperability

Advanced voice processing and SS7 signaling ability to ensure superb VoIP communications experiences. SS7 packets are customizable and compliant with diverse softswitch.

Technical Specification:						
Models	SMG2030	SMG2060	SMG2120	SMG3008	SMG3016	SMG3064 SMG3064R
Sessions	30	60	120	240	480	1890
Segmentation	Enterprise			Carrier-grade		
Telephony ports	1	2	4	8	16	63
Interface	RJ45	RJ45	RJ45	RJ45	RJ45	Fiber Optical
Power Supply	Dual					
Power Requirements	AC Power Supply Range 100 – 240 VAC The power supply will operate at frequencies between 47Hz and 63Hz					
Coder support	G.711A,G.711U, G.729 A/B,G723,G722, GSM, iLBC, RFC 2833, RF 3261, SIPINFO, INBOUND					
IP protocols	TCP/UDP, HTTP, ARP/RARP, DNS, NTP, TFTP, TELNET, STUN, etc.					
SIP Protocol	Supported SIP standards: IETF RFC 3261 (SIP: Session Initiation Protocol); IETF RFC 2327 (SDP–Session Description Protocol); IETF RFC 3550 and 3551 (RTP/RTCP); IETF RFC 2833 (DTMF)					
TDM Signaling Protocols	ISDN PRI/MF R2/SS7 ISUP/SS7 MTP1~3/SS7 SIGTRAN/SS7 TCAP					
Dimensions H*W*D(mm)	44*440*267					44*440*690
Environment	Operating temperature range :0 to +55 °C, 8-90% relative humidity non-condensing Storage temperature range:-20 to +85 °C, 8-90% relative humidity non-condensing					
Routing	Call Routing and translation (PCM↔IP)					
Safety	Compliant with most international standards, please ask Synway or its sales representatives worldwide. Synway would comply all new safety standard to for different regions around the world while needed.					
EMC/EMI	Compliant with most international standards. For compliance documents, please contact Synway’s sales representatives.					
OAM&P	Network Time Protocol(NTP) Web User interface (WebUI) supports configuration via browser SNMP MIBs					



# SMG4000

## GSM/WCDMA/UMTS/VoLTE VoIP Gateway

- Support 4/8/16/32 GSM/WCDMA/CDMA/UMTS/LTE Protocols
- Superior Voice Quality by Designated DSP Chipsets
- Support SMS and A Range of Mobile Applications

Synway SMG4000 Wireless Gateway could be compliant with a variety of wireless/mobile protocols (2G/3G/4G), enabling interconnection between GSM/CDMA/WCDMA/VoLTE network and VoIP network smoothly and safely. It is able to bridge wireless network with IP networks efficiently, regarding to the high-demanding user requirements.

SMG4000 adapts self-propelled SIM card slots, advanced built-in VoIP processors and wireless modules, and helps enterprises and SPs launch diverse cost-efficient and flexible Wireless-to-IP communication systems. SMG4000 could also be applied into a range of systems, including remote billing and charge, Mobility PBX, PSTN backup lines, VoIP localization, SMS platform and more.



VoIP



GSM/UMTS  
VoLTE



IP2Tel  
Tel2IP  
Route



Carrier  
Selection



NAT



Cloud



VLAN



SMS



VPN



QoS

### Key Features and Benefits

- **DSP-based Algorithm**  
DSP-enabled voice optimization to assure crystal voice quality and maximize bandwidth efficiency; High-speed response and connectivity in the extreme network environments, with better run efficiency.
- **High security**  
Support a range of SIM Block manners. In specific environments, SMG4016/SMG4032 (16/32 Ports) could use and activate multiple SIM cards circularly, improve system security, make full use of bandwidth, and increase ROI.
- **Complete Protocols Range**  
Support standard SIP protocols, and could be used worldwide; Support both 2G/3G/4G wireless network (in different versions), including both GSM/WCDMA/VoLTE and More.
- **High Voice Optimization Capability**  
Adopt Synway's homegrown voice optimization technologies to ensure crystal clear communication, including DSP-based 128mc echo cancellation; Telco-grade reliability and continuous high performance in fully loaded capacity and in the long run.
- **High Flexibility and Scalability**  
Could be configured from 4/8/16/32 Ports of Wireless-to-IP transmission, and support a diversity of wireless networks in a single system.
- **User-friendly GUI**  
Easy-to-use service Web based UI configuration and management tools could help accelerate service deployment and simplify platform management.
- **High Interoperability with Terminals**  
Compliant with all brands of terminal mobile devices and a complete range of SIP trunking worldwide, support auto-provision in complex network environment.
- **Telco-Grade Reliability**  
Adopts telco-grade standards and components to design and manufacture, and certified and approved by most telecom operators worldwide.



Technical Specification:					
Features	Model	SMG4004	SMG4008	SMG4016	SMG4032
Models		SMG4004GSM/CDMA/ WCDMA/3G/VoLTE	SMG4008GSM/CDMA/ WCDMA/3G/VoLTE	SMG4016GSM/CDMA/ WCDMA/3G/VoLTE	SMG4032GSM/CDMA/ WCDMA/3G/VoLTE
Sessions		4	8	16	32
Telephony ports		1	2	4	8
TDM Interface		GSM/CDMA/WCDMA/3G/VoLTE			
Interface		RJ45	RJ45	RJ45	RJ45
SIM card slots		4	8	64	128
Power Supply		Single/dual			
Power Requirements		12V DC			
Protocol		SIP, IAX2			
Transport Protocol		UDP, TCP, TLS, SRTP			
Codecs		G.711 (alaw/ulaw), G.722, G.726, G.729A, GSM, ADPCM, Speex			
Voice Capability		ITU-T G.168 LEC			
DTMF Mode		RFC2833, SIP Info, In-band			
Calling Type		Termination (VoIP to GSM/WCDMA), Origination (GSM/WCDMA to VoIP)			
Fax		T.38 and Pass-through			
QoS		DiffServ, ToS, 802.1 P/Q VLAN tagging			
Network		DHCP, DDNS, Firewall, OpenVPN, Static IP, QoS, Static Route, VLAN			
Network Protocol		FTP, TFTP, HTTP, SSH			
NAT Traversal		Static NAT, STUN			
Management Protocol		RADIUS, TR-069*			
PRI switch types		Euro ISDN, nation, Q.SIG			
CAS		MFC R2 (Argentina, Brazil, China, Czech Republic, Colombia, Ecuador, Indonesia, ITU, Mexico, Philippines, Venezuela)			
SS7		ITU, ANSI, China			
Dimensions H*W*D(mm)		260*153*30		440*200*44	
Environment		Operating temperature range :0 to +55 °C, 8-90% relative humidity non-condensing Storage temperature range:-20 to +85 °C, 8-90% relative humidity non-condensing			
Safety		Compliant with most international standards, please ask Synway or its sales representatives worldwide. Synway would comply all new safety standard to for different regions around the world while needed.			
EMC/EMI		Compliant with most international standards. For compliance documents, please contact Synway's sales representatives.			
OAM&P		Network Time Protocol(NTP) Web User interface (WebUI) supports configuration via browser SNMP MIBs			

### Specific Points of SMG4000

SMG4000 provides customers with efficient communication efficiency and helps them create more values, and both system integrators and users could benefit from a more reliable and versatile manner of transition between wireless and IP networks. Some of specific values include:

- Integrated “Gateway Plus Built-in SIM Bank” architecture for better communication efficiency.
- DSP-enabled voice optimization to assure crystal voice quality and maximize bandwidth efficiency.
- High security and privacy for users via automatic-exchange of different SIM cards and Networks.
- High-speed response and connectivity in the extreme network environments, with better run efficiency.
- Telecom grade reliability and continuous high performance in fully loaded capacity and in the long run.
- Homegrown hardware and software technologies to guarantee relevant upgrading and customization.
- More compact hardware design to save space and ensure advantages of power consumption and cost.

### Operator & Frequency

Model	Frequency
<b>2G</b>	
SMG4000G	GSM:850/900/1800/1900MHZ
SMG4000C	CDMA:800MHz
SMG4000GZ	GSM:850/900/1800/1900MHz
<b>3G</b>	
SMG4000W	GSM:900/1800MHz UMTS:900/2100MHz
SMG4000WA	GSM:850/900/1800/1900MHz UMTS:850/1900MHz
SMG4000WT	GSM:850/900/1800/1900MHz, UMTS:850/2100MHz
SMG4000WZ	GSM:8850/900/1800/1900MHz UMTS:50/900/1900/2100MHz
<b>4G</b>	
SMG4000LC	FDD LTE:B1/B3, TDD LTE:B38/B39/B40/B41 TDSCDMA:B34/B39, WCDMA:B1, CDMA2000:BC0 GSM:1X/EVD, 900/1800MHz
SMG4000LE	FDD LTE:B1/B3/B5/B7/B8/B20, TDD LTE:B38/B40/B41 WCDMA:B1/B5/B8, GSM:B3/B8
SMG4000LV	FDD LTE: B4/B13
SMG4000LT	LTE FDD: B1/B2/B3/B4/B5/B7/B8/B28; LTE TDD: B40 WCDMA: B1/B2/B5/B8; GSM: B2/B3/B5/B8

### SMG4000 Technical Values:

- Future-Proof Architecture

With the latest edge-cutting technology, not only satisfy today’s needs, but meet the future needs, including Cloud, Mobility and UC.

- Customizability For Your Need

According to actual needs of users, offer free custom-made services, new features, help users to achieve differentiated advantage.

- Rich Functionalities for Diverse App.

Combining requirements of thousands of users, SMG4000 owns a wealth of functions to meet both personalized and standardized needs.

## Hybrid VoIP Gateway & UC Platform

- Interface with FXO, FXS, T1, E1, GSM, CDMA, 3G, VoLTE, IP
- Optional Inbuilt Server, Standalone for any applications
- Telco Grade Standards in Both Hardware and Software

In hybrid VoIP & TDM era with diverse and rapidly-growing needs of unified communications and services, Synway UNIWAY VoIP Gateway adopts the latest modular architecture with built-in server, and opens a new milestone to maximize VOIP and TDM network's value for SP and application developers. One of major advantage of UNIWAY is to reduce time to market and introduce innovative applications more efficiently and effectively. Tailored to satisfy diverse customers' needs, UNIWAY, with its open and standardized format, enables users to develop a range of applications.

The hybrid architecture of UNIWAY allows for standard protocols between different network components and ensures high independence and interoperability, which better caters to sophisticated communications. Also, in the Mobile Internet Era, UNIWAY brings about efficiency and unparalleled cost advantages for developers by optimizing R&D and integrating an array of data, voice, video and other applications.



VoIP



Hybrid



IP2Tel  
Tel2IP  
Route



Carrier  
Selection



USSD



Cloud



VLAN



SMS



VPN



QoS

### Key Features and Benefits

- **Flexible configuration for any network**  
Compliant with diverse networks (FXO, FXS, T1, E1, J1, GSM, CDMA, 3G, VoLTE, IP): support various multimedia processing capability (conferencing, fax, compression and SuPerFormTM echo cancellation for voice enhancement and an array of Protocols (SS7, SIGTRAN, ISDN PRI, CAS, R1, R2, Wireless).
- **Compliant with any IP-Based applications**  
With optional inbuilt industrial server, UNIWAY series are compliant with any IP-based applications; it also even supports any category of third party software, including UC, IP-PBX, Contact Center and more. In legacy PSTN network, UNIWAY could converge applications via internal modules.
- **Low to High Scalability**  
Modular architecture ensures flexibility and expandability from low density to high density. Modular design allows for easy configurations, system upgrading or general maintenance.
- **Multimedia Convergence**  
Adopt 1000M-Ethernet switching chipset, UNIWAY's media stream exchanges in IP packets, and access to soft switching system via Media Gateway Controller, ensuring high-level applications are streamlined.
- **Diverse Media Resources**  
Support high-capacity voice playback and Codecs, conferencing, faxing; Support T.38/T.30; optimized for IP-PBX, IVR and ACD applications, with EXT IVR server or GUI management.
- **Carrier-Grade Reliability**  
Special power system with standby redundancy; advanced cooling system to reassure long-standing robustness ; special air cleaner to protect against dust accumulation inside chassis; Inside temperature control and alert system; No need to change wiring when changing functional modules.

Technical Specification:		UNIWAY2000/UNIWAY2100		
Features	Model			
Functional module available:	UMG-1016: 16*FXO, 16*FXS, or hybrid 8*FXS+8*FXO	UMG-2012: 1, 2, or 4E1(T1)	UMG-4008: 4 or 8 Wireless Ports (GSM/CDMA/WCDMA/3G/4G)	
Voice Processing Codecs	A-law, $\mu$ -law, PCM8, PCM16, IAM-ADPCM, VOX, MP3, GSM, G.729A/B, G.722, G.723, iLBC etc;			
Signaling interface	SS7 supports MTP, TUP and ISUP, SCCP, TCAP, MAP			
SIP Protocol	Supported SIP standards: IETF RFC 3261 (SIP: Session Initiation Protocol); IETF RFC 2327 (SDP-Session Description Protocol); IETF RFC 3550 and 3551 (RTP/RTCP); IETF RFC 2833 (DTMF)			
Network Interface	E1/T1/J1/FXS/FXO 2 *TCP/IP 1,000M Ethernet (RJ-45); 2 *LAN Ethernet (RJ-45); 4 USB ports;			
Development Environment	Windows OS: Windows2000/XP/2003/Vista/NT; Linux OS: Including RH7.2/RH9.0/AS4/FC4/SUSE10; Programming language: ANSI C/C++, Microsoft Visual C++, C#, Delphi			
Security and Certifications	Lighting-proof grade: Level 4; Certification: FC/CE/China CCC For RoHS compliance, please contact Synway's sales representatives;			
Physical Characteristics	Dimensions: 2U form factor: 88.1mm (H) x 482.6mm (W) x 430mm (L) Net Weight: about 8Kg (different for the number of optional modules)			
Power Requirement	AC: 90-120V or 200~265V (SELECT RIGHT RANGE ON SHELF), Frequency: 50~60Hz; Power consumption: different for configuration, less than 350Watt;			
Environment Requirement	Ventilation: normal; Operating temperature: 0°C-40°C; Relative humidity: 10%-85%; Avoid dust accumulation; Anti-electrostatic: please Grounded; Installation recommendation: mounted on standard 19-inches rack;			
Routing	Call Routing and translation (PCM $\leftrightarrow$ IP)			
Safety	Compliant with most international standards, please ask Synway or its sales representatives worldwide. Synway would comply all new safety standard to for different regions around the world while needed.			
EMC/EMI	Compliant with most international standards. For compliance documents, please contact Synway's sales representatives.			
OAM&P	Network Time Protocol(NTP) Web User interface (WebUI) supports configuration via browser SNMP MIBs			

## Transcoding Gateway

- Support Complete DSP-enabled Transcoding Range
- Highly Efficient Coding & Decoding IP/TDM Network
- Support 500/2000-Port of Transcoding Capability per Unit

With the popularity of IP communications, increasing need for transcoding between various protocols and coding formats becomes more important. Large-capacity VoIP applications call for high efficient transcoding functionality. Normally, designated hardware-enabled transcoding equipment, not software-based, would be the best option for high demanding VoIP carrier.

To address the transcoding issue, Synway's hardware-based SBO transcoding gateway could help VoIP operators achieve multiple transcoding in IMS or PSTN network.

SBO adopts 1U standard design and built in LINUX OS based upon POWERPC+DSP hardware infrastructure. Each chassis supports dual Ethernet interfaces. With transcoding, routing, number filtering, number transformation and other functionalities, SBO serves as the perfect connectivity point between IP network and any IP devices.



### Key Features and Benefits

- Compliance with diverse protocols

Supports SIP signaling protocols: SIP V1.0/2.0, the RFC3261); diverse codecs: G.711A, G.711U, G.729, G723, G722, AMR, iLBC DTMF mode RFC2833, SIP info, INBAND; Network protocols: TCP / UDP, HTTP, ARP/ RARP, DNS, NTP, TFTP, Telnet, STU.

- User-friendly GUI

With web-based management software, you can administrate and configure the SBO gateway remotely and check running status, call statistics, call routing, etc.

- Optimize Communication Efficiency

Process large capacity voice forwarding and up to 500-2000 concurrent IP transcoding, ensuring high efficiency for whole VoIP system. With SBO transcoding capability, systems could handle highly scalable surging calling traffic. With intelligent routing configurations, SBO could conduct flexible IP-IP routing in distributed or centralized communication system.

- Advanced Features for Different Network Environments

Supports dual Ethernet interface for telecom redundancy. With number transformation and filtering functionality, SBO could remove the head or end of number, or add a prefix or suffix, while needed.

- Embedded Infrastructure, Crystal Clear Voice Quality

Introducing embedded hardware for transcoding, as well as Telco-grade echo cancellation technology to ensure HD voice quality. SBO gateway also embraces dual power for redundancy.

# SIM Bank

## Manage the SIM Cards Smartly and Romotely

- Up to 128 cards slot in single chassis
- Support all SIM cards categories worldwide
- Deliver unmatched level of unblocking security

SIMbank is Synway's latest security device used jointly with Synway's SMG4000 series wireless gateway through the network. With SIMbank, SMG4000 wireless can leverage SIM cards remotely, which realize interdependency and separation between Wireless gateway and remote SIM cards. In addition, as a compliant software in SIMbank, SIMcloud centralized management system for unified management could administrate SMG4000 wireless gateway and SIMbank to form low-to-high density wireless-IP calling system.



### Basic Introduction

The main function of SIMbank is to manage and assign SIM cards on remote. SIMbank could identify categories of SIM cards, manipulate the mobile numbers for any designated SIM card, authorize Administrator, ensure that resources and data security, and monitor the whole system status. It also supports TCP/UDP, HTTP, ARP/RARP, DNS, NTP, TFTP, TELNET, STUN IP and other network protocols, and realizes address modification and dynamic allocation of IP address, domain name analytic and other functions.

### Key Features and Benefits

- 64/128 SIM card slots;
- 1U height, 19-inch chassis;
- Long \* height \* deep: 440\*44\*200 mm;
- 12V DC power supply, 2\*RJ45 interface;
- Embedded Linux system, and upgraded on remote;
- FPGA adopts online loading mode to upgrade system rapidly;

### SIM Cloud

Cloud-based integrated SIMcloud platform is used to manage and monitor SMG4000 series wireless gateway and SIMbank device, as well as configure and administrate SIM cards on remote.

- SIMbank and SMG4000 series Wireless Gateway could be managed through software registration;
- SIMcloud is software based on PC or server Simserver;
- Support remote SIM card management and information exchange;
- Support forwarding and configuration of SIM card information;
- Support local virtualization of remote SIM cards;
- With Web Management interface;

**SIMcloud+SIMbank Networking Scheme:**

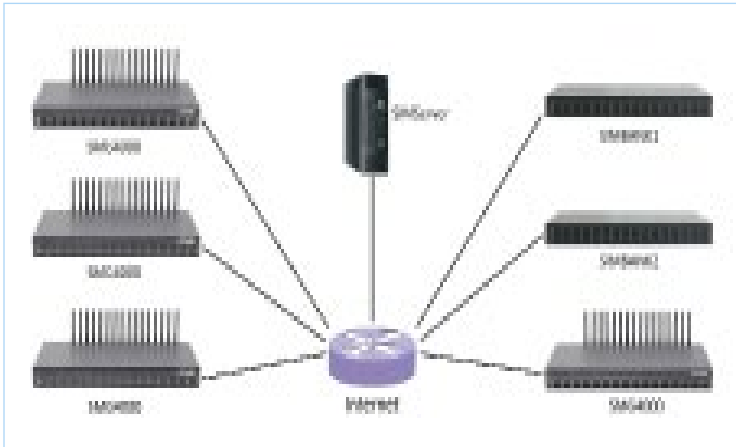

● SIMcloud based on SIMserver realizes the communication and management between SIMbank and SMG4000 Wireless Gateway, and isolates SIM cards from remote wireless gateways.

Technical Specification:		
Features	Model	SIM64/128
SIM Slots		64/128
Network Port		Amount: 2 (10/100 BASE-TX (RJ-45)) Self-adaptive bandwidth supported Auto MDI/MDIX supported
Console Port		Amount: 1 (RS-232) Baud rate: 115200bps Connector: Mini-USB connecting line Data bits: 8 bits Stop bit: 1 bit Parity unsupported Flow control unsupported Note: Follow the above settings to configure the console port; or it may work abnormally.
Network Protocols		IP v4, UDP/TCP, PPPoE, DHCP, FTP/TFTP ARP, RARP, NTP, HTTP, Telnet
Power Requirements		Input power: 100-240V/50-60Hz AC Input Current: 1.2A
Dimensions		L×H×W=440mm*44mm*200 mm
Net Weight		2.4kg
Environment		Operating temperature:0°C-45°C Storage temperature:-20°C-85°C Operating Humidity:8%-90% non-condensing Storage humidity:8%-90% non-condensing



# WEB Management Interface

## User-friendly Configuration Toolkit

- Simplest Way to Resolve Most Sophisticated Requirements

With complete understanding about enterprise and carrier's headaches, Synway's SMG VoIP Gateway adopts the simplest and straight-forward configuration to achieve users' most sophisticated objectives. With this configuration toolkit, IT managers from enterprises and carriers could control VoIP gateways effortlessly and efficiently, despite of their limited knowledge about VoIP gateways. With minimum time and expenditure, enterprises and carriers gain maximum values.

- User-friendly WEB Management

User-friendly WEB management tool has been built into Synway SMG series gateway, and users could log in their account to manage all synway gateways via web and effortlessly monitor real-time operation status, system information, PSTN line status and other data and information, which helps users to save the cost on network management and maintenance.



Figure 1: Basic data display

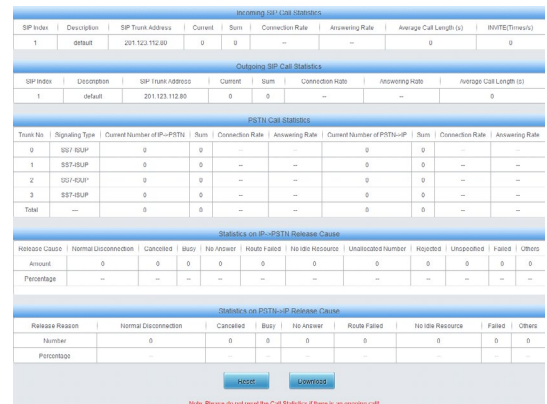

Figure 2: call statistics

- Flexible VoIP Configuration

Five types of VoIP setting are available, including SIP Setting, SIP Trunking setting, SIP account setting, SIP trunk group setting and media setting.

- Compliance with a complete range of protocols

Synway SMG series gateway seamlessly complies with various protocols. Fitting to a variety of communication environments, SMG family could configure PCM parameters via web-based management software. The PCM Settings includes five categories: PSTN, PCM, PCM trunk group, calling-reception rule, and reception timeout.

Worthy of notice, users could set up SS7 parameter in the menu only when the configuration item "Signaling Protocol" in the PCM settings is set to SS7-TUP or SS7-ISUP. SS7 Settings includes eight ones: SS7, TUP, TUP Number Param, ISUP, Number Param, Original CalleeID Pool, Redirecting Number Pool (Hidden item) and SS7 Server.

ISDN setting is available in the menu only when the configuration item "Signaling Protocol" on the PCM settings interface is set to ISDN User Side or ISDN Network Side. Moreover, SMG web management software also could set other parameters, such as fax, routing, number filtering, and number manipulation and so on.

- Simple Configuration for Media Processing

With the popularity of IP communications, increasing need for transcoding and media processing between various protocols and coding formats becomes more significant.

## Device Cloud-Based Management System

- Real-Time Monitoring of VoIP Gateway Status
- Management Capability for More Than 10,000 Devices
- DCMS Features Cloud-based Management Capability
- Superior Network Access Traversal (NAT) Capability

Synway Device Cloud-Based Management System (DCMS), based on the Internet, is used for monitoring, maintenance and debugging for Synway's VoIP gateways on the field. It helps users leverage Synway's products efficiently and unfailingly, as well as improves controllability and manageability over entire communication systems.

Device ID	Serial No #	Device Name #	Device Status #	Load #
000002870	SN/01016	OK	0%	
00000167	SN/02120	OK	0%	
000002330	SN/01032	OK	0%	
000001440	SN/01016	OK	2%	
000001192	SN/01032	OK	0%	
000022087	SN/01016	OK	0%	
000005082	SN/02120	OK	0%	
000001190	SN/01032	OK	0%	
000022087	SN/01016	OK	0%	
3634	SN/010088-BO	OK	0%	

Serial No #	Device Type #	Device Name #	Status #	Current Time #	Set User Name #	Software Version #	Hardware #	Location #
000000008	01101	000000008	OK	2015-08-04 10:26:15	张永刚	1.0.1	2015-01-13132	2101
000000007	21010	000000007	OK	2015-08-04 10:26:15	张永刚	1.0.2	2015-01-13134	
000000009	01101	000000009	OK	2015-08-04 10:26:15	张永刚	1.0.1	2015-01-13133	2101
000000006	01101	000000006	OK	2015-08-04 10:26:15	张永刚	1.0.1	2015-01-13132	2101
000000005	21010	000000005	OK	2015-08-04 10:26:15	张永刚	1.0.2	2015-01-13134	
000000004	01101	000000004	OK	2015-08-04 10:26:15	张永刚	1.0.1	2015-01-13133	2101
000000003	01101	000000003	OK	2015-08-04 10:26:15	张永刚	1.0.1	2015-01-13132	2101
000000002	21010	000000002	OK	2015-08-04 10:26:15	张永刚	1.0.2	2015-01-13134	
000000001	01101	000000001	OK	2015-08-04 10:26:15	张永刚	1.0.1	2015-01-13133	2101
000000000	01101	000000000	OK	2015-08-04 10:26:15	张永刚	1.0.1	2015-01-13132	2101

### Key Features and Benefits

- Real-Time Monitoring of VoIP Gateway Status  
DCMS is a unified management platform developed by Synway to manage all Synway's VoIP gateways remotely, providing centralized monitoring and management over Synway VoIP gateways in the networks.
- Management Capability for More Than 10,000 Devices  
DCMS could monitor over 10,000 SMG series VoIP gateways simultaneously, but it just consumes less than 10% CPU processing capability for registration and connectivity procedures.
- DCMS Features Cloud-based Management Capability  
Two types of cloud-based management modes are delivered by DCMS: public cloud mode managing devices online through public cloud platform, and private cloud mode in which DCMS users could implement Synway's dedicated software for devices management.
- Superior Network Access Traversal (NAT) Capability  
DCMS possesses automatic NAT traversal capability, and need not configure port mirroring setting while building up connection between intranet and internet, or between any networks.
- Relevant Allocation of Communication Resources  
DCMS could improve operational and maintenance efficiency and optimize communication resources for users. In large-scalability communications systems, DCMS could reasonably and effectively allocate communication resources to better fit to specific application scenarios, helping users build VoIP communication system with minimum CAPEX and OPEX.

# Typical Applications

## SMG1000 FXO/FXS Gateway

- The Best Cost and Reduce OPEX by 50%  
More HW/SW technologies are adopted to solve core technological problems, and which assures system ran efficiently in the enduring complex communication environments.

- Excellent voice quality and telco-grade reliability  
DSP-enabled voice optimization to assure crystal voice quality and system agility as well as maximize bandwidth efficiency.

- Eliminate headaches in rival products  
The performance and function can be renewed and updated by advanced synway-own technology, ensuring voice detection of FXO calling and DTMT accuracy, Comply with most platforms, Plug and Play.

- High-speed response with minimum bandwidth  
High-speed response and connectivity in the extreme network environments, with better run efficiency.

- User-friendly GUI and central administration  
Easy-to-use service Web based UI configuration and management tools could help accelerate service deployment and simplify platform management.

- Customizability Satisfies all Specific Needs  
Homegrown inherited soft-hard technology to renew and update performance and functionalities. More compact hardware architecture saves space and assures unparalleled power consumption and cost.

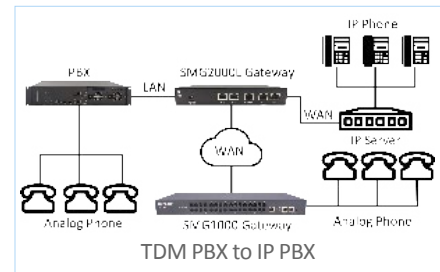
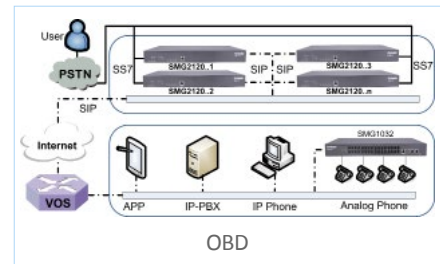
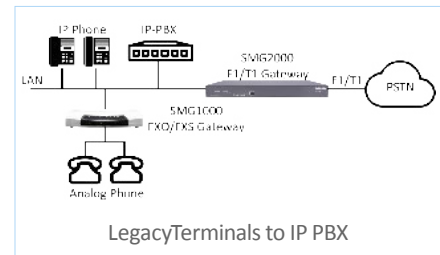

## SMG2000 E1/T1 Gateway

SMG2000L/2000, the smallest sized and most economical E1/T1 PRI/SS7 SIGTRAN Gateway, adopts long standing field-proven voice processing technologies, based on continually optimized algorithm of dedicated chipsets in diverse networks. It could offer high audio quality, despite of low bandwidth in extreme environment. For that, enterprise users could enjoy smooth communications effortlessly and efficiently, in situations of restricted bandwidth and high density switching.

- Support and interface with any applications and platforms based on E1/T1 networks for carrier, SPs, enterprise.

- User-friendly configuration, GUI, centralized administration, customizable features and functionalities.

- DSP-enabled voice optimization to assure crystal voice quality and maximize bandwidth efficiency and reliability.

- High-speed response and connectivity in the extreme network environments, with better run efficiency.

- Telecom grade reliability and continuous high performance in fully loaded capacity and in the long run.

- Homegrown core technologies, Mini-sized footprint assure unparalleled cost and user convenience for enterprises and SPs.

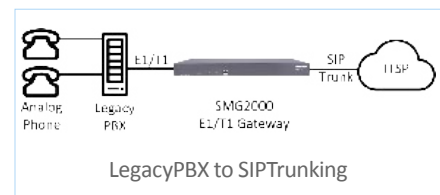
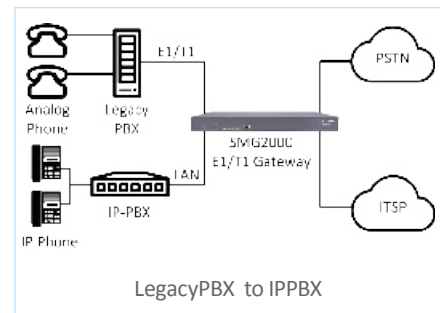

## SMG3000 PRI/SS7/SIGTRAN Gateway

- Build-in SS7, SIGTRAN, SIP, ISDN, R2  
Complimentary standardized SS7 Packets(Up to 64 SS7 links, ISUP, MTP1~3, TCAP), SIGTRAN, and SIP for any carrier networks worldwide; Field-proven by over 50 largest operators from European, China, USA, India, Brazil, South America.

- Maximum CPS(Calling Per Second)  
Telecom-style DSP algorithm has been optimized for over decades, assuring seamless compliance with any network environment. Plentiful DSP resources are allocated for maximum calling per second (CPS), signaling, media processing, bandwidth optimization, Telco redundancy.

- 99.9999% Availability in Full Load  
Support 1/2/4/8/16/64E1 (30/60/120/240/480/1,920Chs) per unit, with higher system responsiveness capability in extreme network for better operational results; High performance and stability in cases of unstable (low) bandwidth and high capacity.

- User-friendly Cloud-based Management  
With complete understanding about SPs and operator's headaches, SMG3000 adopts the simplest and straight-forward configuration to achieve SPs and Operators' most sophisticated objectives. Over 1,000 units of SMG3000 can run together; User-friendly configuration, GUI, centralized administration, customizable features and functionalities.

- Robust Telco-Grade Architecture  
Dual power supply, 1U compact structure, industrial heating sink system, dual 1,000M Ethernet interfaces, and Telco' grade hardware architecture ensure 200,000Hr MTBF and 0-defective rate in long lifecycle.

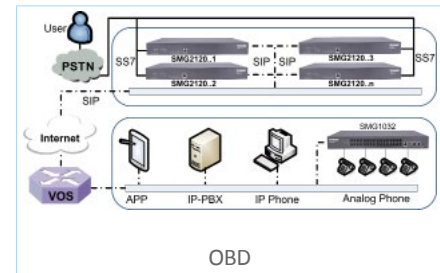
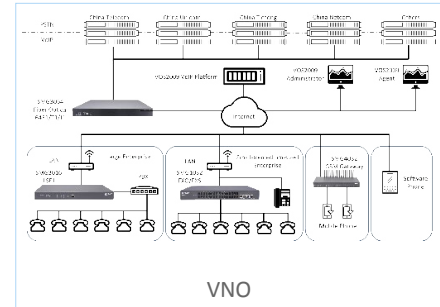
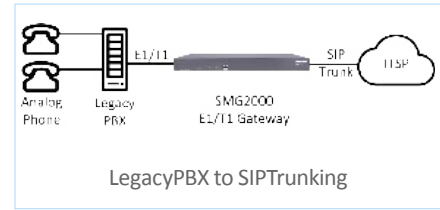

## SMG4000 GSM/3G/4G VOLTE Gateway

- Support a Range of System  
Could be applied into a range of systems, including, mobility PBX, PSTN backup lines, VoIP localization, SMS notification platform, cloud-based services, contact service center, and GSM/CDMA Trunking.

- Seamless Interoperability  
Compliable with a variety of wireless/mobile protocols (2G/3G/4G), enabling interconnection between GSM/CDMA/WCDMA/VoLTE network and VoIP network smoothly and safely.

- Higher Business Values  
Integrated "Gateway Plus Built-in SIM Bank" architecture (SMG4016/4032) for better communication efficiency. Mobile SMS-based commercial delivers advantages of low cost, dismiss complexity, and also save time and human cost.

- Perfectly Combine Voice & Data  
DSP-enabled voice optimization to assure crystal voice quality and maximize bandwidth efficiency; separately process voice or data transmission, or handle simultaneous voice and data transmissions in a single system.

- Hi-Speed & Accuracy Processing  
Field-approved in diverse extreme environments, including low bandwidth and unstable wireless signals. High-speed response and connectivity in the extreme network environments, with better run efficiency.

- Boost Operational Efficiency  
Significantly improve operation efficiency while applying SMG4000 in the data processing & SMS transmission. Telecom grade reliability and continuous high performance in fully loaded capacity and in the long run; Homegrown hardware and software technologies to guarantee relevant upgrading and customization.

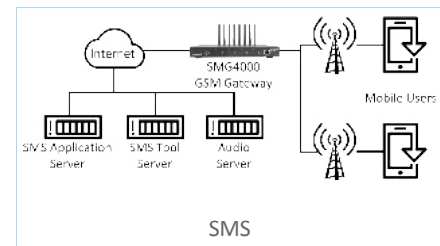
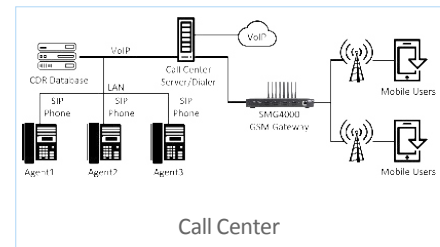
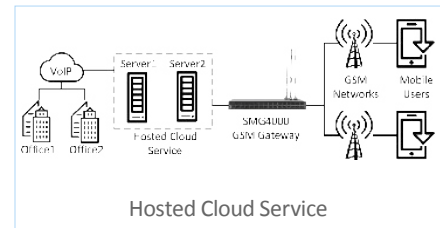



Since  
1992



CTI and  
Vo P Gateway



1000+  
employees



3000+  
Partners

As a leading VoIP enabling-technologies provider in China, Synway has been partnered with applications & solution providers worldwide to deliver turkey solutions for enterprises and telecom carriers. Based on long-standing business network, Synway's appliances and equipments, with third-party compliant software platforms from mainstream application providers, have served 5,000 plus customers, including contact centers, financial institutes, public security, government agencies, service providers, hospitality and operators.

In ever-changeable environments, Synway's long-term goal would be of partnership with vendors of cloud-based unified communications, providing enterprises and SPs with a complete range of cloud-based applications, including Video and Audio Conferencing, Contact Center, IP-PBX, Unified Messaging, Social Media Services and more. For in-house IPR and better customer value, Synway provides strategic partners with customized OEM or ODM services to localize more efficiently. To achieve 0-defective rate, Synway has adopted ISO9001, CE, FCC, RoHS, 3C and more since 2001.

Synway Information Engineering Co., Ltd. (Headquarter)  
Synway R&D Building, No.3756, Rd. Nanhuan.  
Binjiang District, Hangzhou, P.R.China 310053  
Tel: (86) 571 88860561  
Fax: (86) 571 88850923  
Email: info@synway.net  
All Copyrights are reserved. Jan 2018

Technical Support  
Tel: (86) 571 86692545  
Tel: (86) 571 88864579  
Mobile: (86) 18905817070 (24\*7)  
Email:techsupport@synway.net

No notice for any change in future in this catalog, For more information or latest update, please visit Synway website.